

UNCONTROLLED DOCUMENT

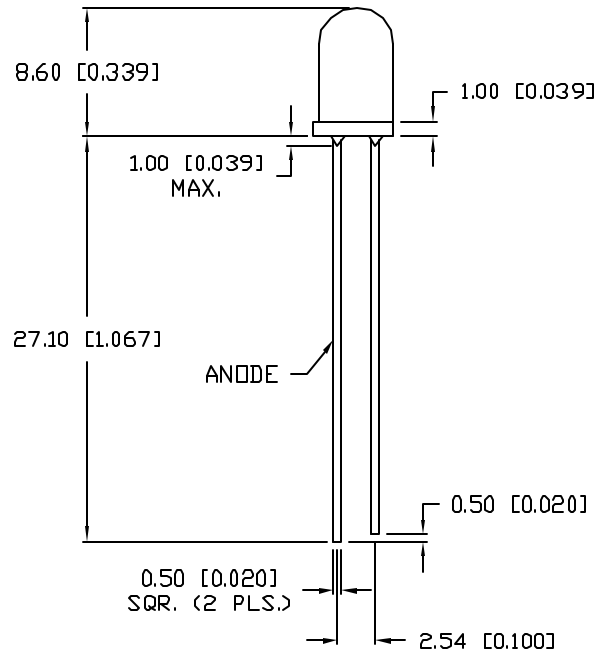
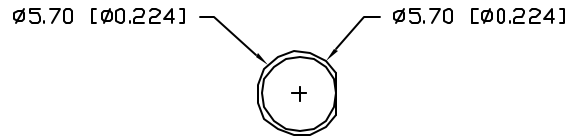

PART NUMBER		REV.
OED-CL-1L1		D
REV.	E.C.N. NUMBER AND REVISION COMMENTS	DATE
A	E.C.N. #10BRDR. & REDRAWN.	5.29.95
B	E.C.N. #10157.	4.26.96
C	E.C.N. #10BRDR.	1.5.98
D	E.C.N. #10BRDR. & REDRAWN.	11.14.02

ELECTRO-OPTICAL CHARACTERISTICS $T_A=25^\circ\text{C}$ $I_f=20\text{mA}$

PARAMETER	MIN	TYP	MAX	UNITS	TEST COND
PEAK WAVELENGTH		880		nm	
SPECTRAL BANDWIDTH		80		nm	
FORWARD VOLTAGE		1.9		V_f	$I_f=50\text{mA}$
REVERSE VOLTAGE	5.0			V_r	$I_f=100\mu\text{A}$
RADIANT INTENSITY		30		mW/SR	$I_f=50\text{mA}$
HALF ANGLE		± 10		degrees	
EPOXY LENS FINISH: WATER CLEAR LENS					

LIMITS OF SAFE OPERATION AT 25°C

PARAMETER	MAX	UNITS
PEAK FORWARD CURRENT*	1	A
STEADY CURRENT	100	mA
POWER DISSIPATION	190	mW
DERATE FROM 25°C	-1.2	mW/ $^\circ\text{C}$
OPERATING TEMP.	-25 TO +85	$^\circ\text{C}$
STORAGE TEMP.	-40 TO +85	$^\circ\text{C}$
SOLDERING TEMP.	+260	$^\circ\text{C}$
2.0mm FROM BODY		3 SEC. MAX

* $t_p < 100\mu\text{s}$, $t_p/T=0.01$

*UNLESS OTHERWISE SPECIFIED TOLERANCES PER DECIMAL PRECISION ARE: X= ± 1 (± 0.039), XX= ± 0.5 (± 0.020), XXX= ± 0.25 (± 0.010), XXXX= ± 0.127 (± 0.005). LEAD SIZE= ± 0.05 (± 0.002), LEAD LENGTH= ± 0.75 (± 0.030), MIN. = $\frac{+0.00}{-0.00}$ DECIMAL PRECISION MAX. = $\frac{+0.00}{-0.00}$ DECIMAL PRECISION

UNCONTROLLED DOCUMENT

REV. D	PART NUMBER OED-CL-1L1	<p>CONFIDENTIAL INFORMATION</p> <p>THE INFORMATION CONTAINED IN THIS DOCUMENT IS THE PROPERTY OF LUMEX INC. EXCEPT AS SPECIFICALLY AUTHORIZED IN WRITING BY LUMEX INC., THE HOLDER OF THIS DOCUMENT SHALL KEEP ALL INFORMATION CONTAINED HEREIN CONFIDENTIAL AND SHALL PROTECT SAME IN WHOLE OR IN PART FROM DISCLOSURE AND DISSEMINATION TO ALL THIRD PARTIES.</p> <p>RELIABILITY NOTE</p> <p>OUR MANY YEARS OF EXPERIENCE DATA ACCUMULATION INDICATE THAT SOLDER HEAT IS A MAJOR CAUSE OF EARLY AND FUTURE FAILURE. PLEASE PAY ATTENTION TO YOUR SOLDERING PROCESS.</p>	<p>290 E. HELEN ROAD PALATINE, IL 60067-6976 PHONE: +1.847.359.2790 US WEB: www.lumex.com TW WEB: www.lumex.com.tw</p>
T-5mm x 8.6 HIGH PERFORMANCE INFRARED EMITTING DIODE, WATER CLEAR LENS.		DRAWN BY: GT CHECKED BY: APPROVED BY:	DATE: 5.24.90 PAGE: 1 OF 1 SCALE: N/A

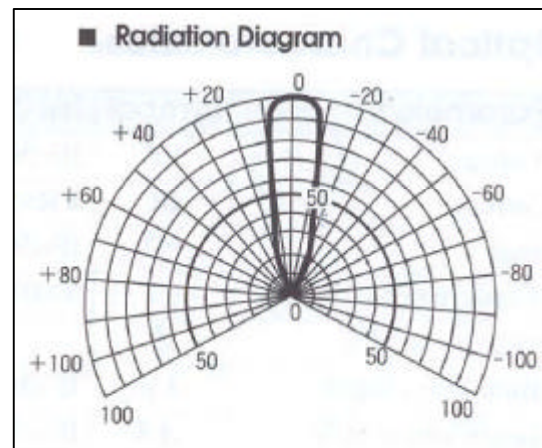
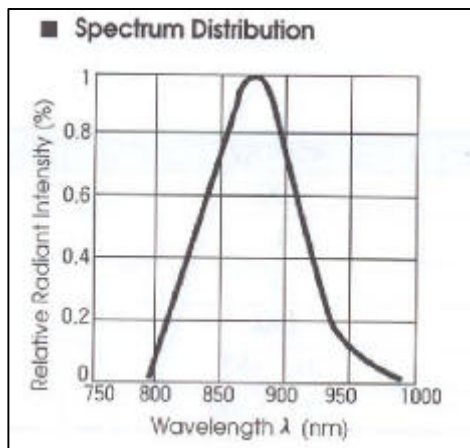
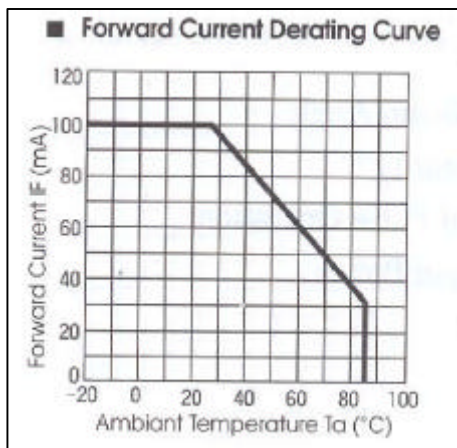
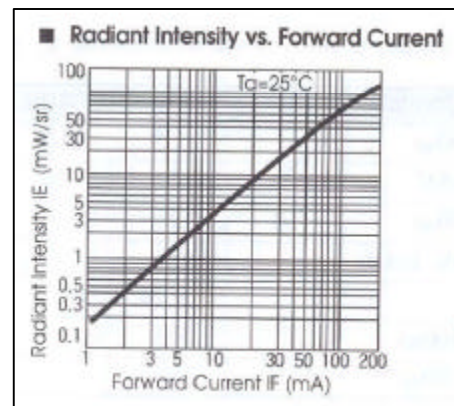
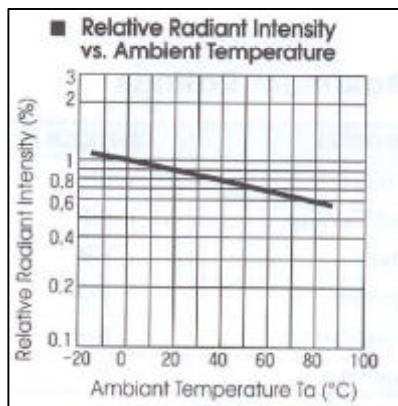
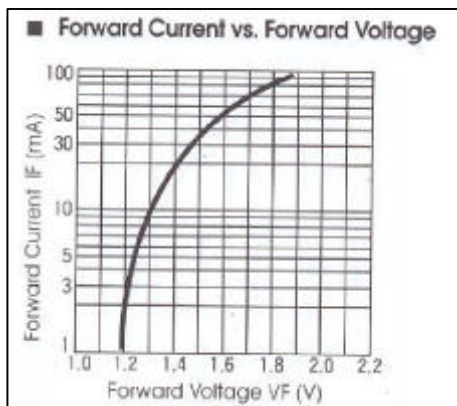

*UNLESS OTHERWISE SPECIFIED TOLERANCES PER DECIMAL PRECISION ARE: X=±1 (±0.039), X.X=±0.5 (±0.020), X.XX=±0.25 (±0.010), X.XXX=±0.127 (±0.005). LEAD SIZE=±0.05 (±0.002), LEAD LENGTH=±0.75 (±0.030). MIN.= +DECIMAL PRECISION -0.00 MAX.= +0.00 -DECIMAL PRECISION

REV.	PART NUMBER OED-CL-1L1
------	---------------------------

CONFIDENTIAL INFORMATION
THE INFORMATION CONTAINED IN THIS DOCUMENT IS THE PROPERTY OF LUMEX INC. EXCEPT AS SPECIFICALLY AUTHORIZED IN WRITING BY LUMEX INC., THE HOLDER OF THIS DOCUMENT SHALL KEEP ALL INFORMATION CONTAINED HEREIN CONFIDENTIAL AND SHALL PROTECT SAME IN WHOLE OR IN PART FROM DISCLOSURE AND DISSEMINATION TO ALL THIRD PARTIES.



290 E. HELEN ROAD
PALATINE, IL 60067-6976
PHONE: +1.847.359.2790
US WEB: www.lumex.com
TW WEB: www.lumex.com.tw

CHARTS FOR OED-CL-1L1

RELIABILITY NOTE
OUR MANY YEARS OF EXPERIENCE DATA ACCUMULATION INDICATE THAT SOLDER HEAT IS A MAJOR CAUSE OF EARLY AND FUTURE FAILURE. PLEASE PAY ATTENTION TO YOUR SOLDERING PROCESS.

DRAWN BY: BC	CHECKED BY:	APPROVED BY:	DATE: 8.18.03
			PAGE: 1 OF 1
			SCALE: N/A